

JC

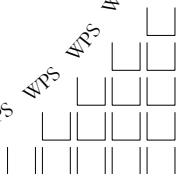

Nose

Mouth

Score

†

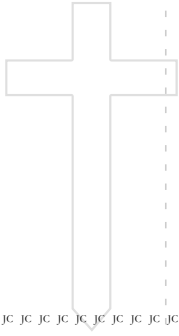

JC



JDAW



MPM



ARM



WPS



JC

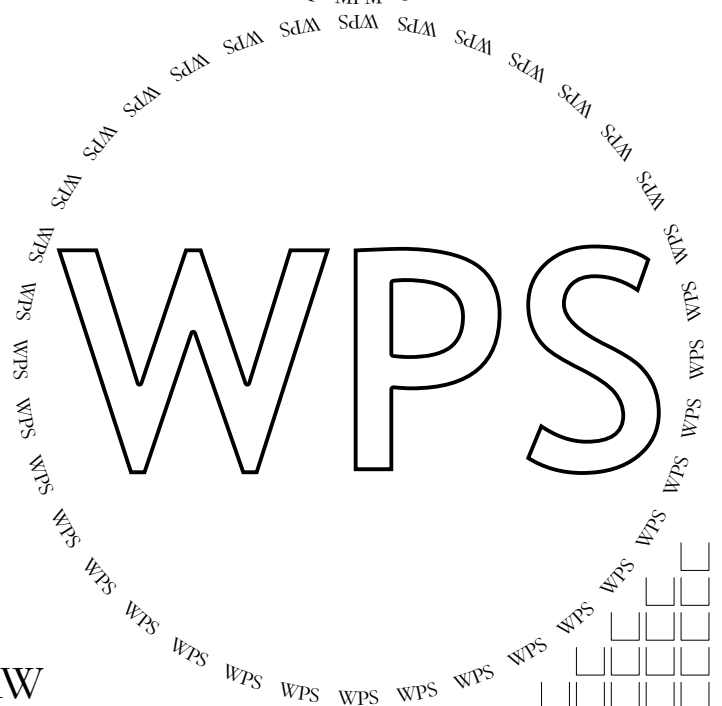
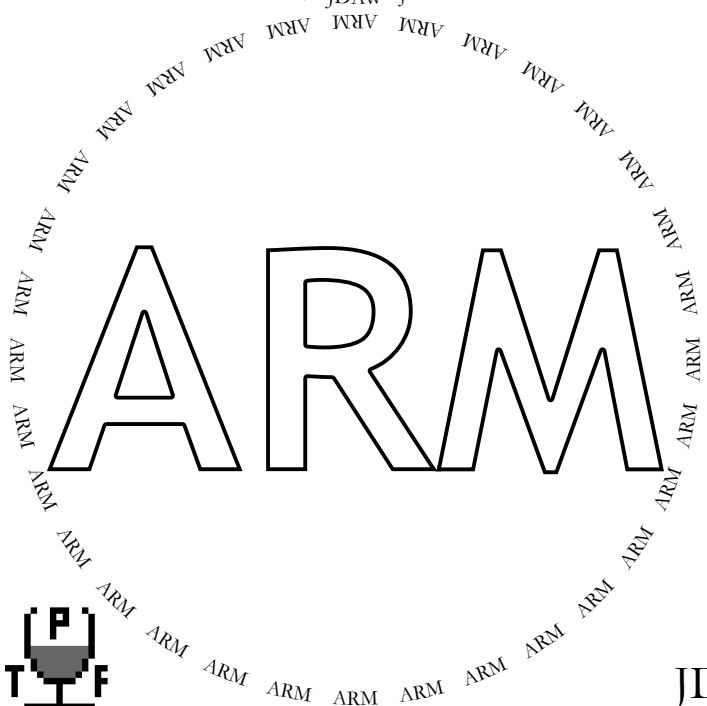
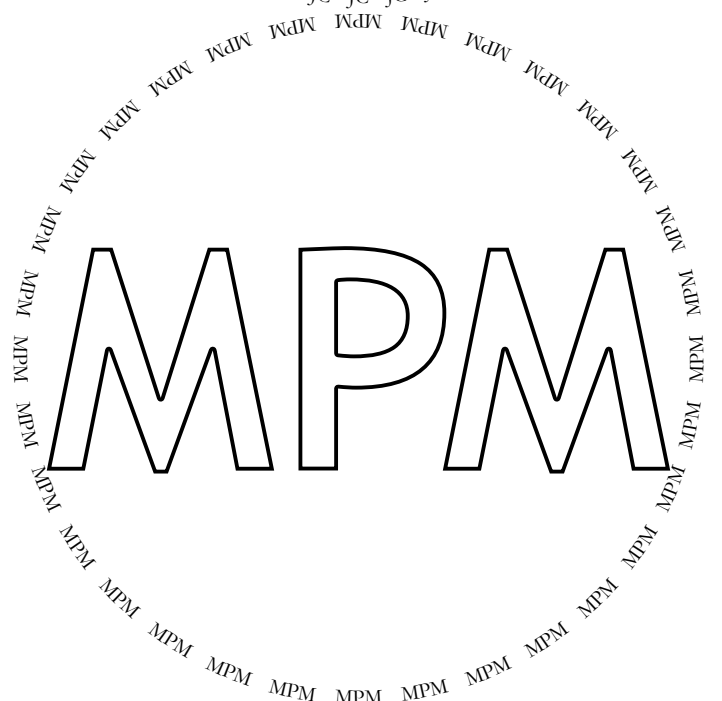
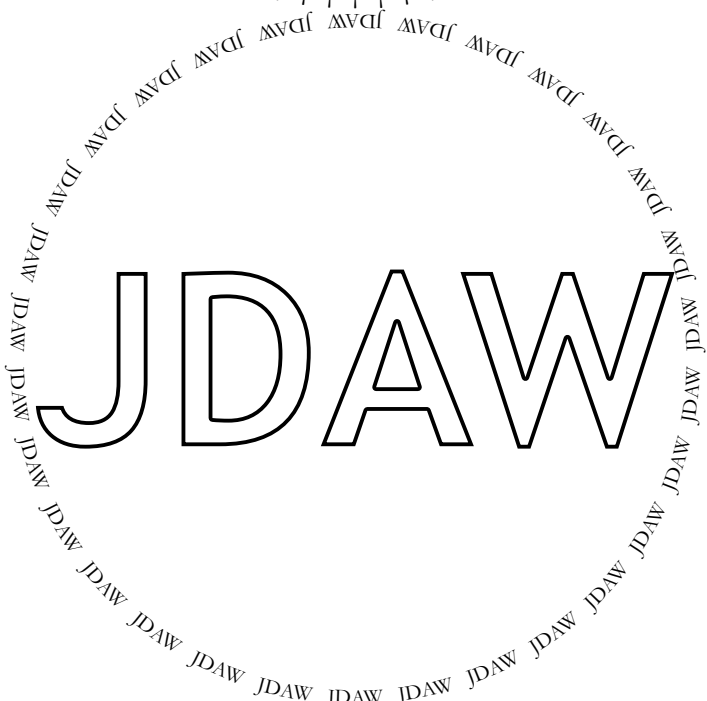
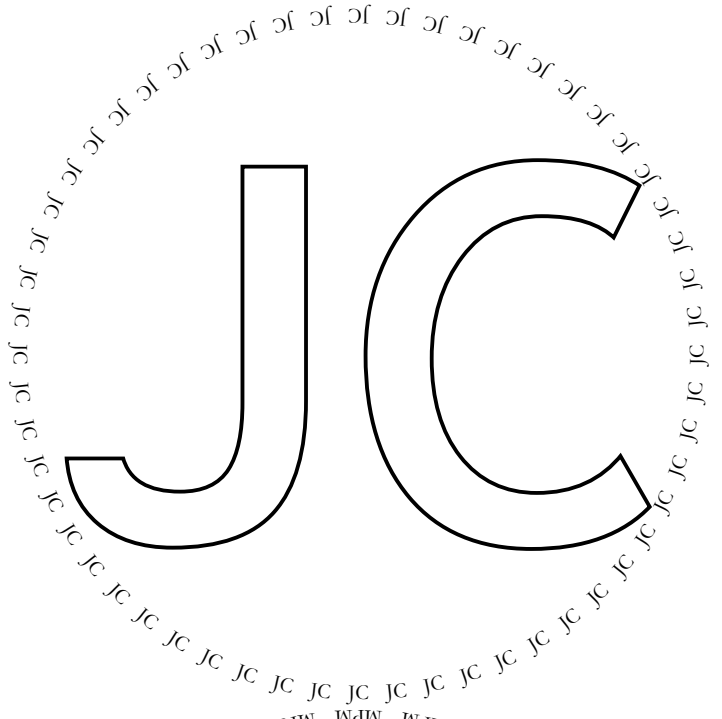
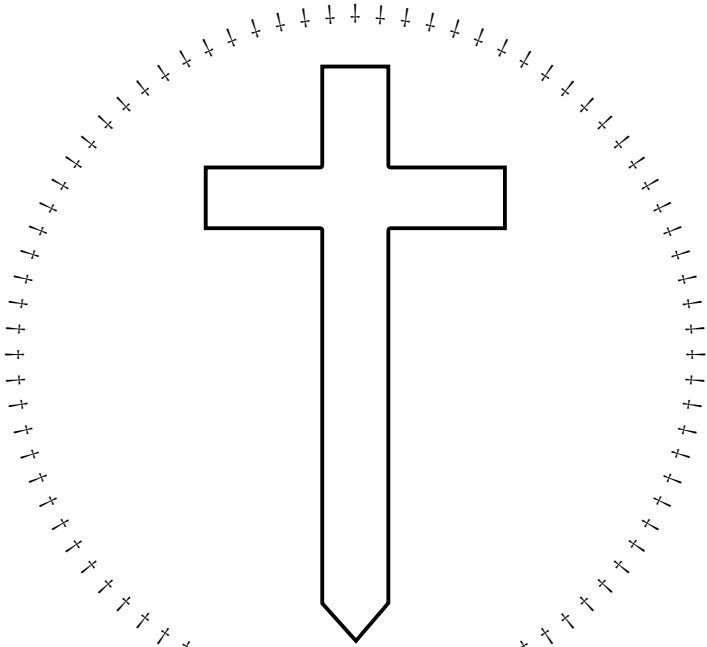

JDAW

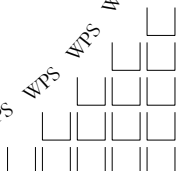

Nose

Mouth

Score

†

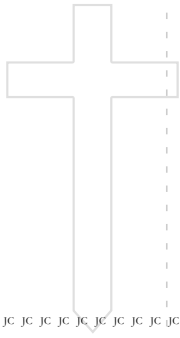

JC



JDAW



MPM



ARM



WPS



JDAW

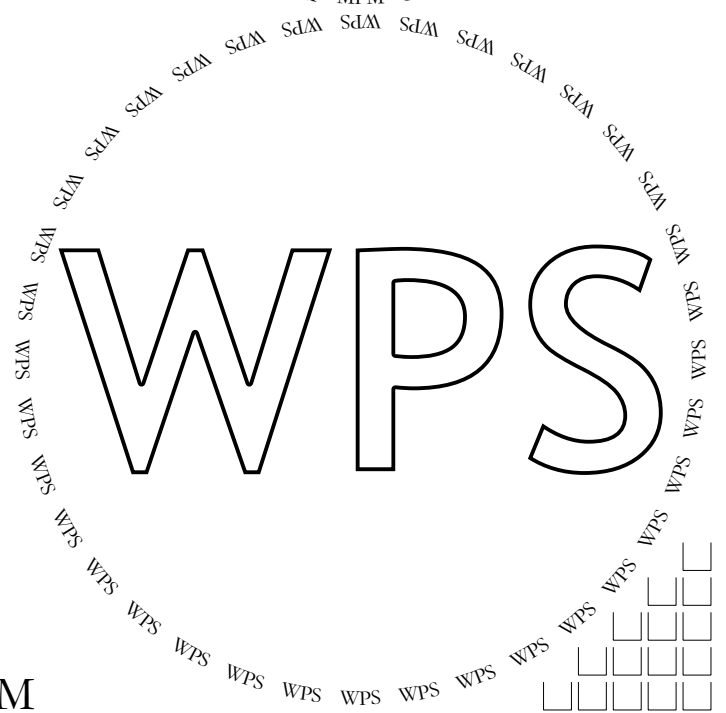
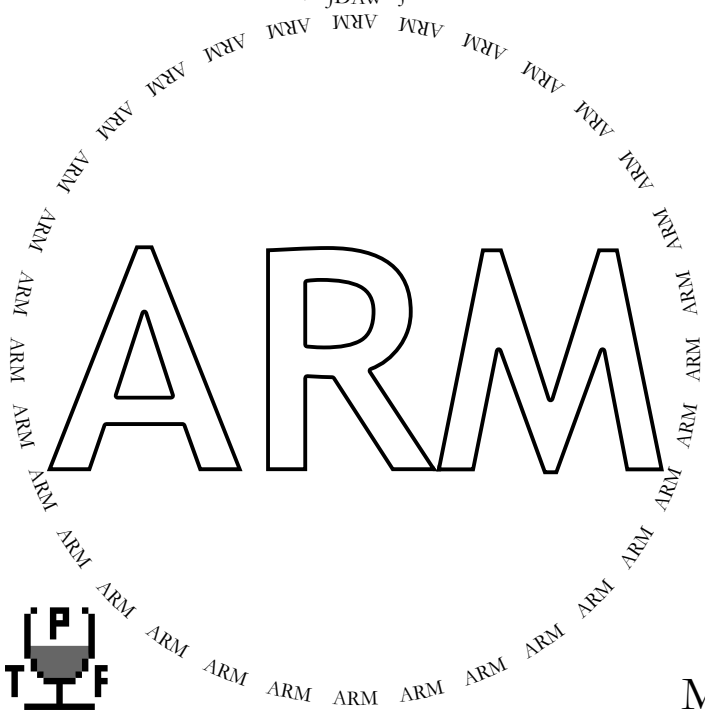
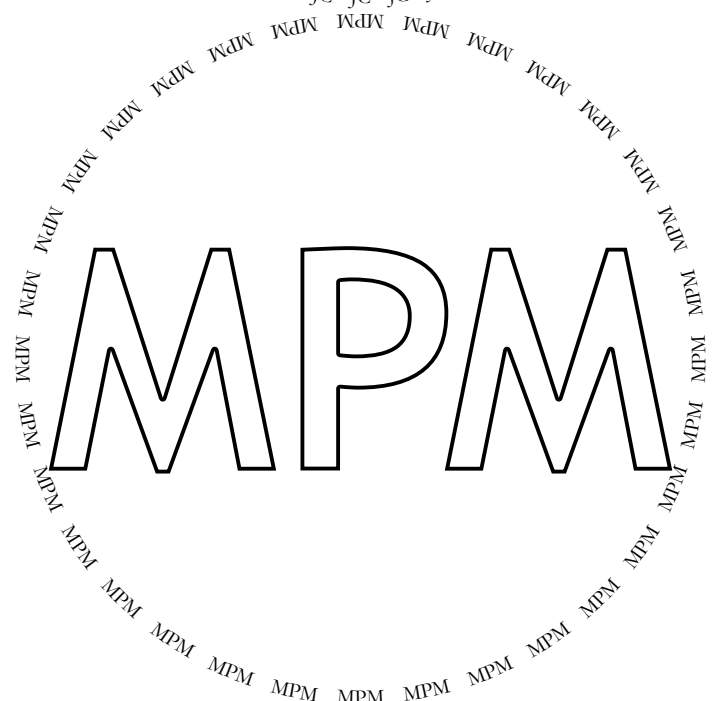
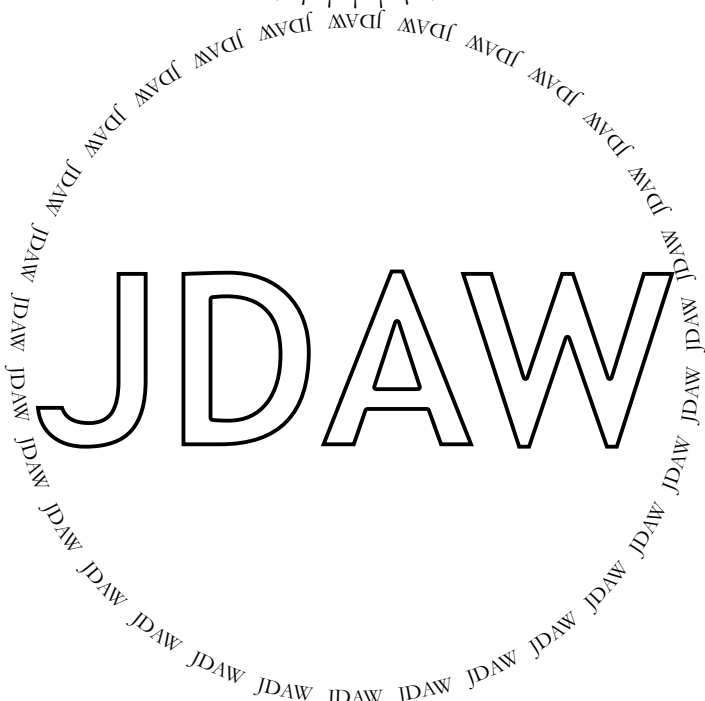
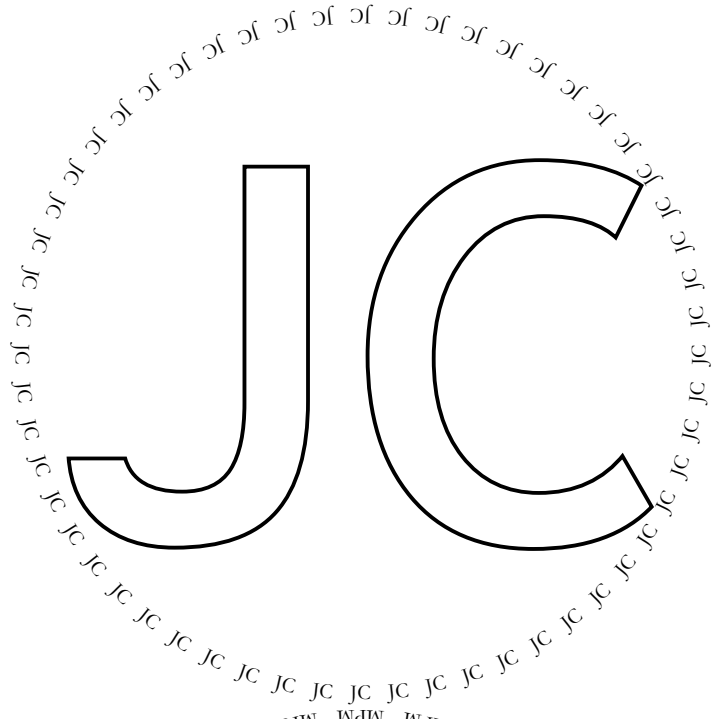
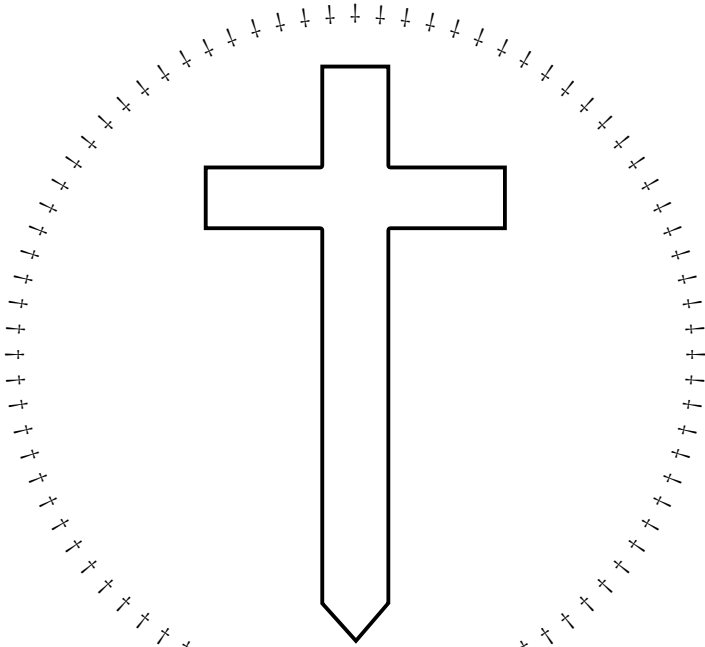

MPM

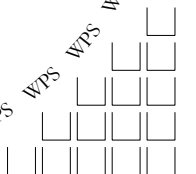

Nose

Mouth

Score

†

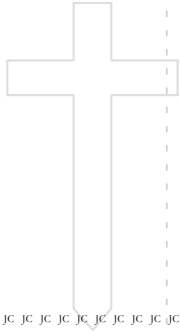

JC



JDAW



MPM



ARM



WPS



MPM

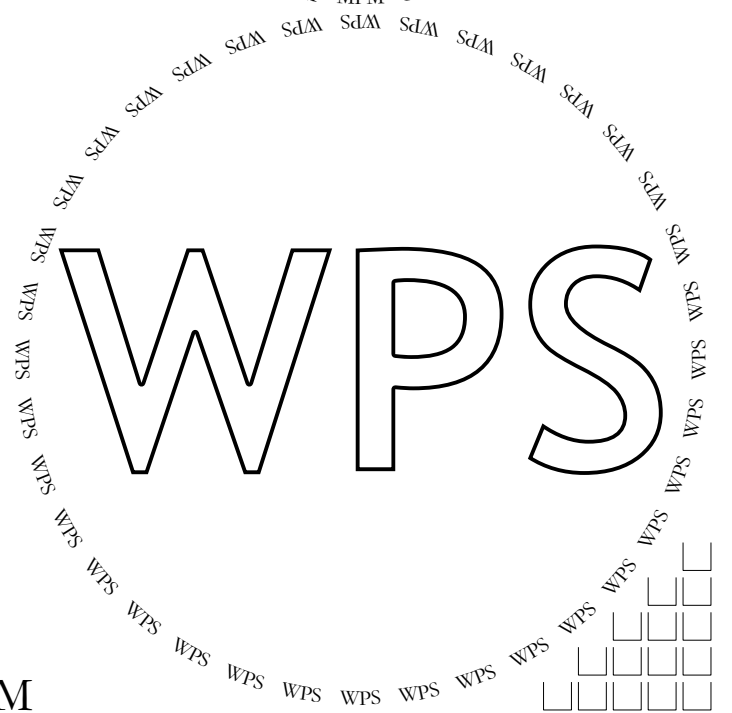
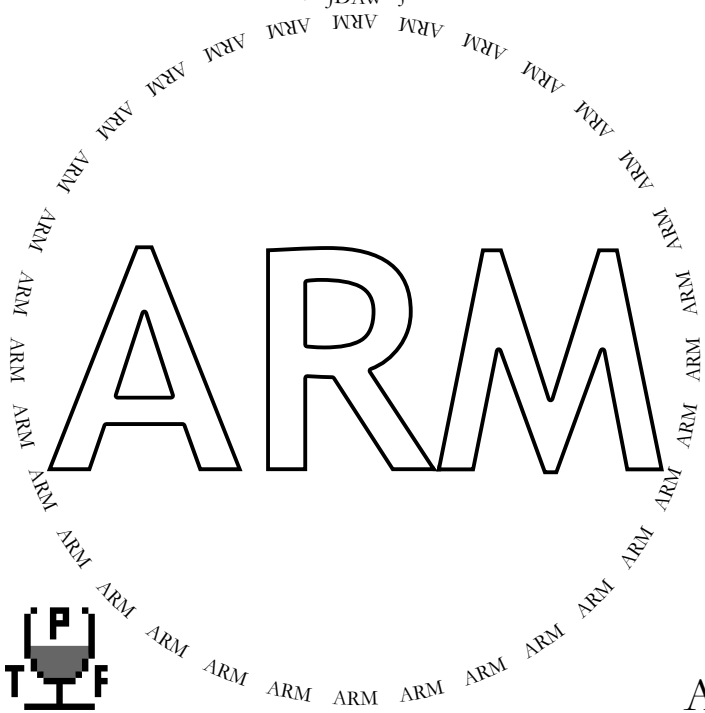
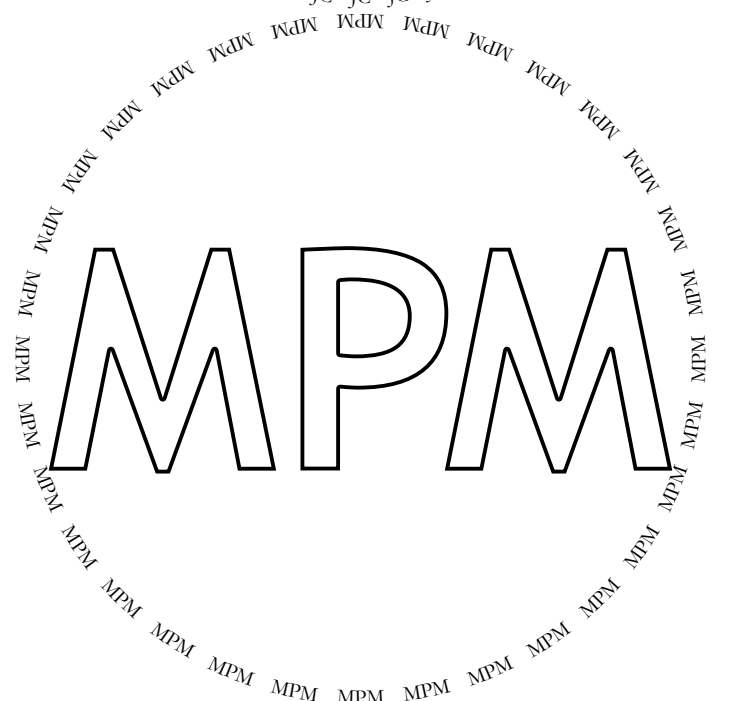
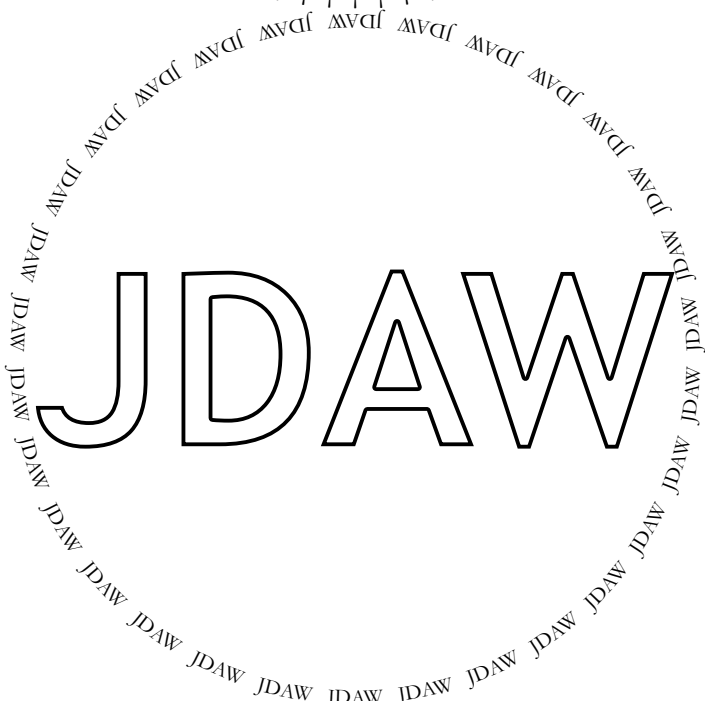
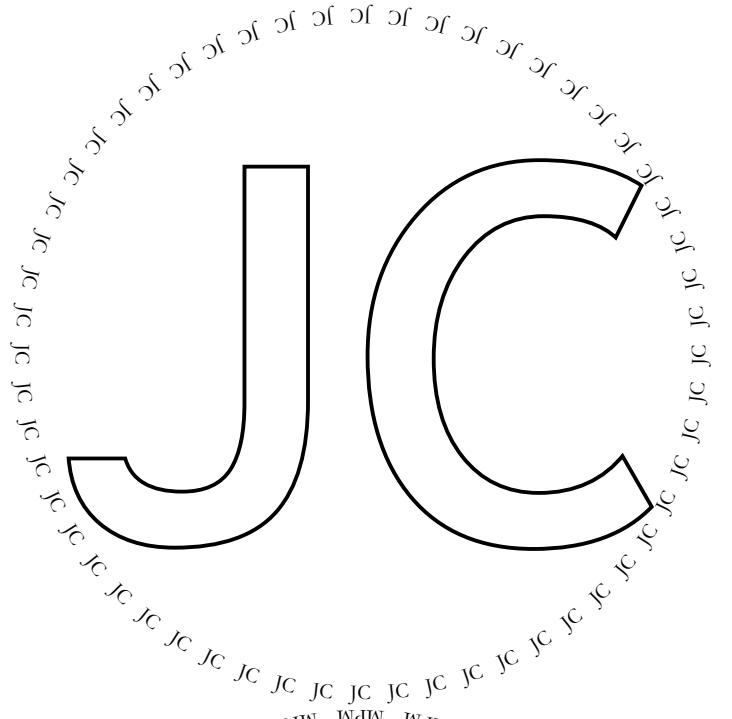
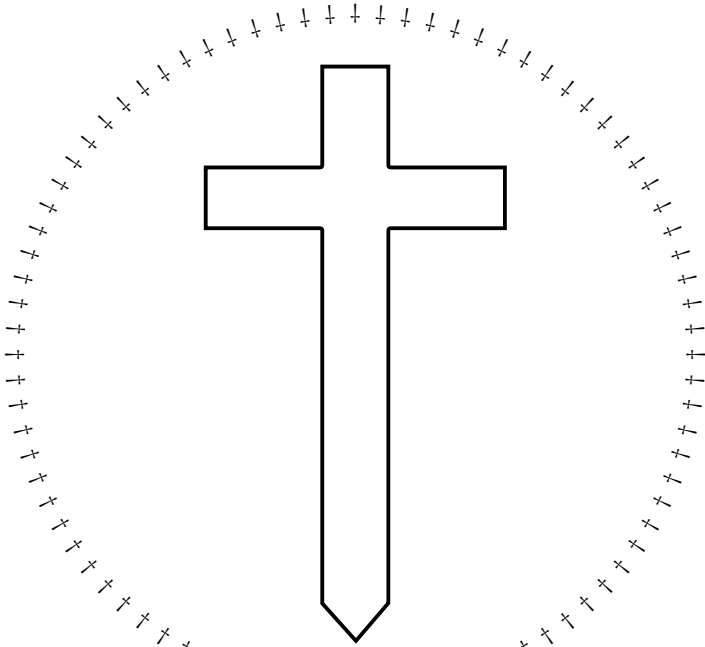

ARM

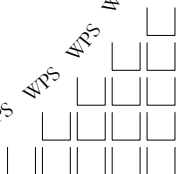

Nose

Mouth

Score

†

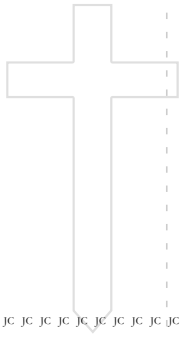

JC



JDAW



MPM



ARM



WPS



ARM

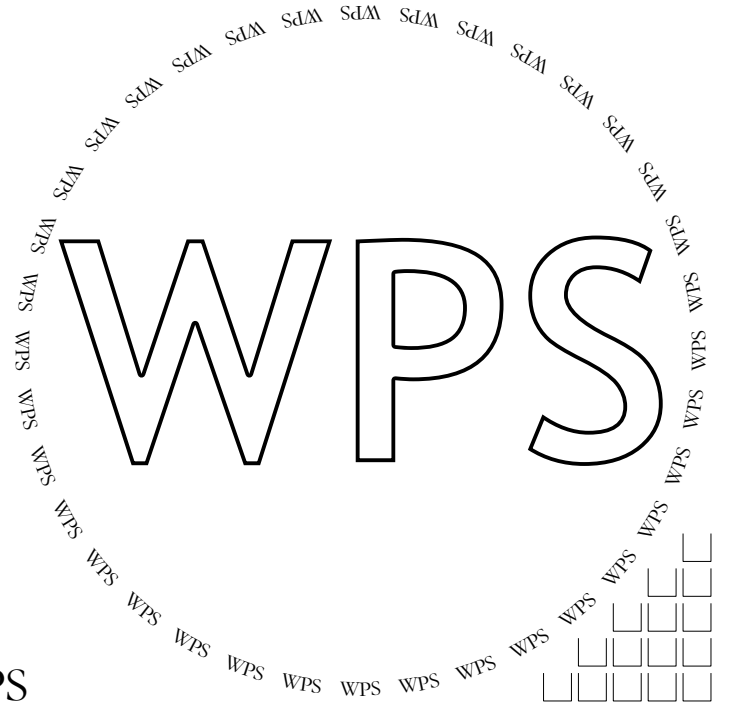
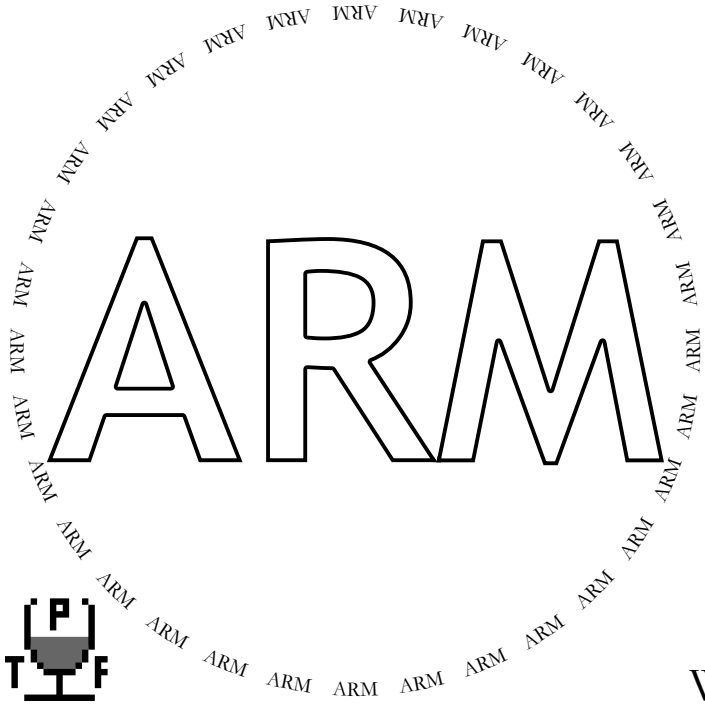
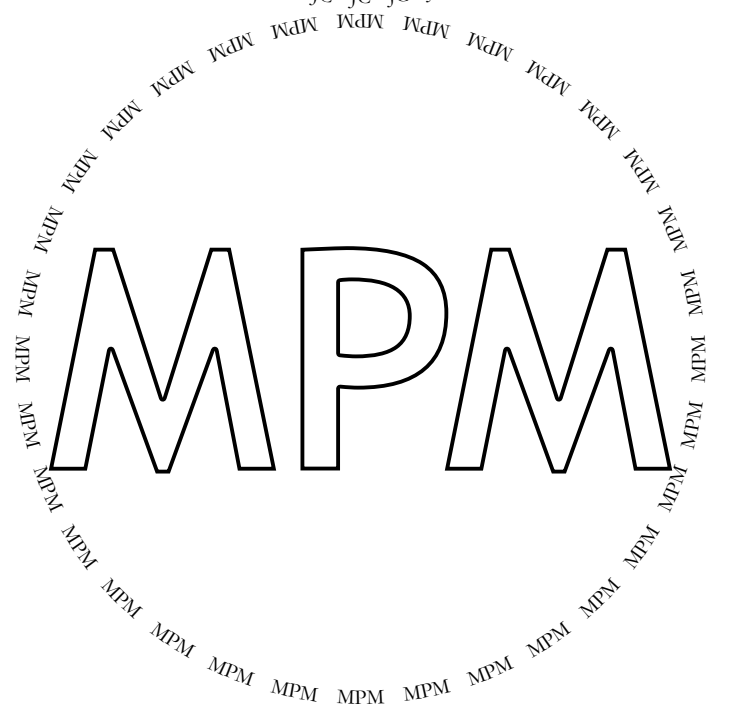
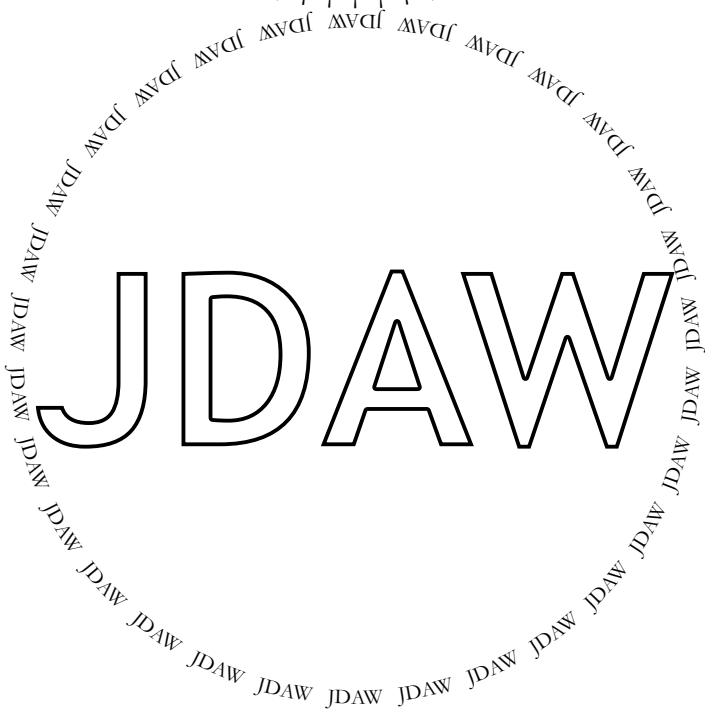
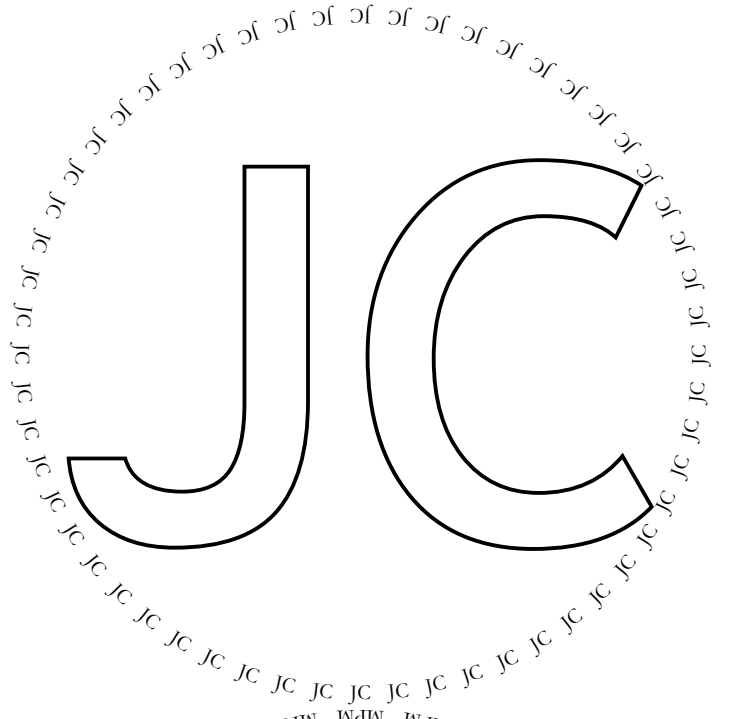
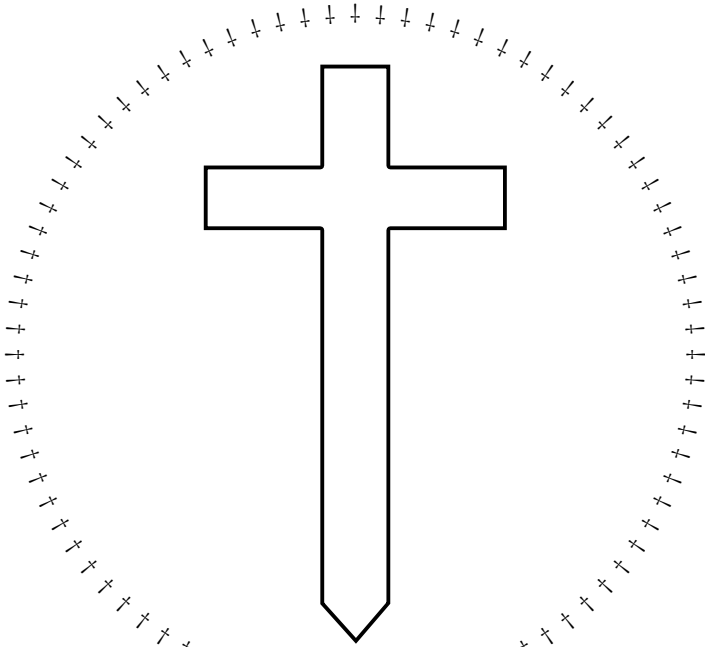

WPS

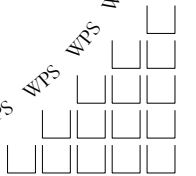

Nose

Mouth

Score

†

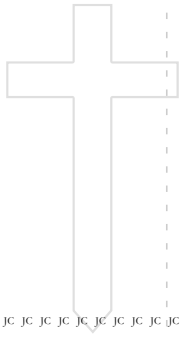

JC



JDAW



MPM



ARM



WPS



WPS

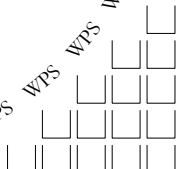
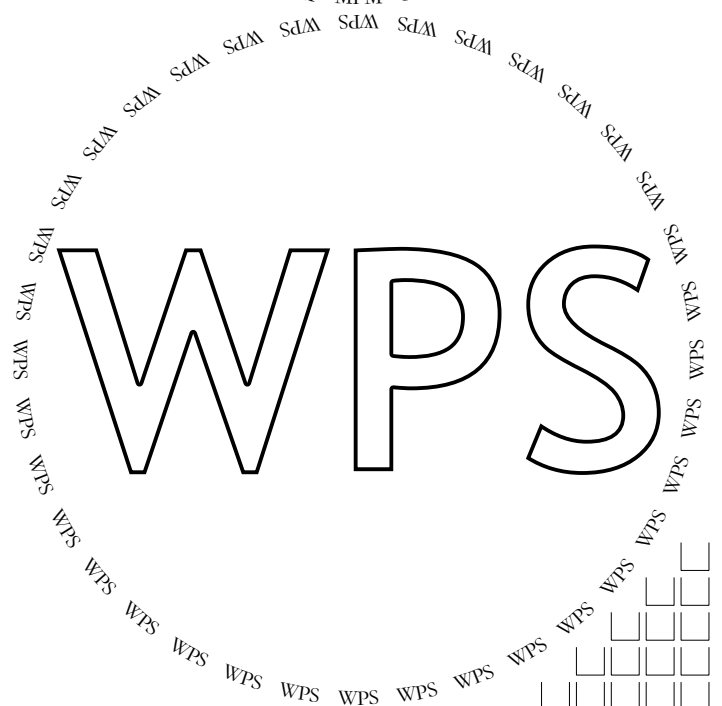
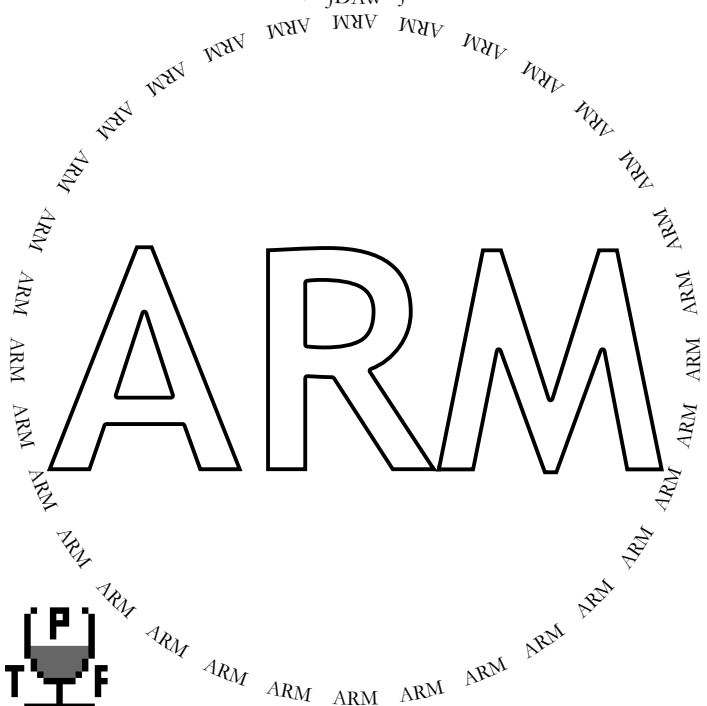
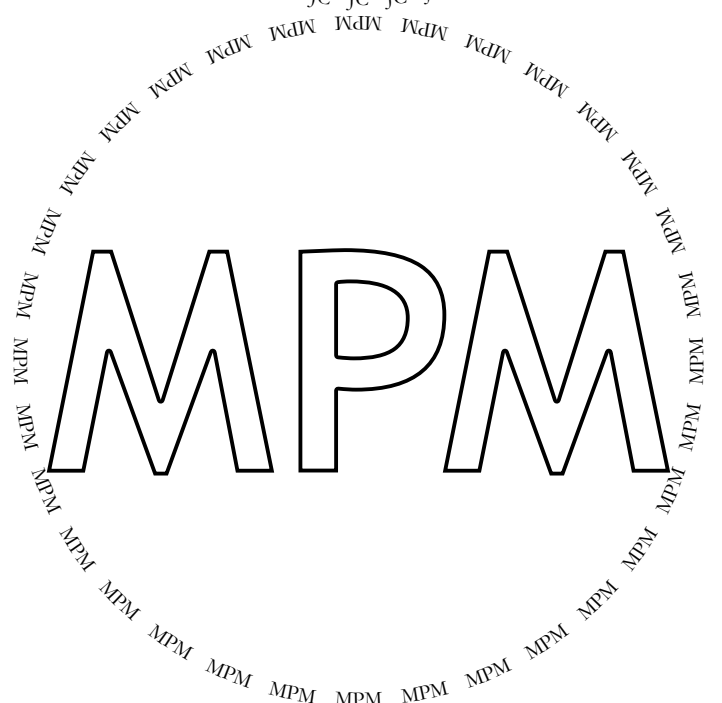
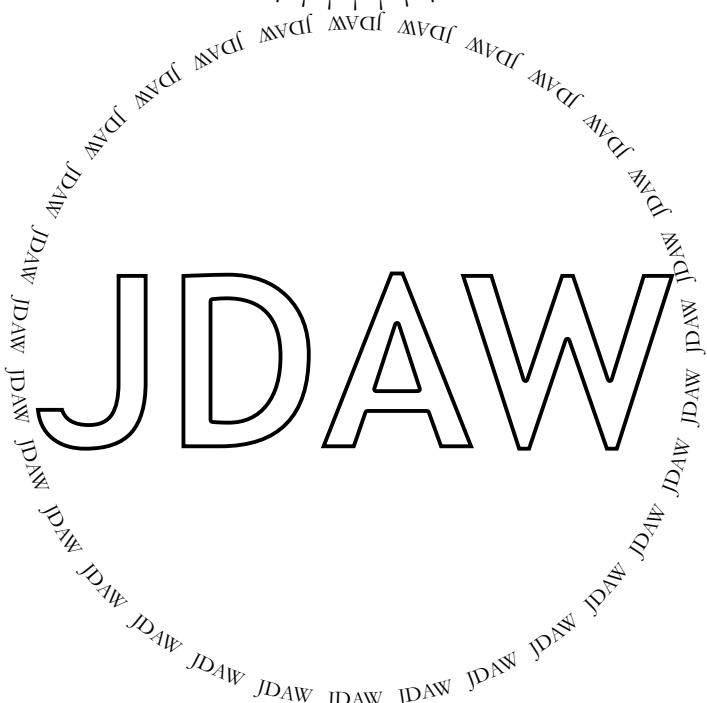
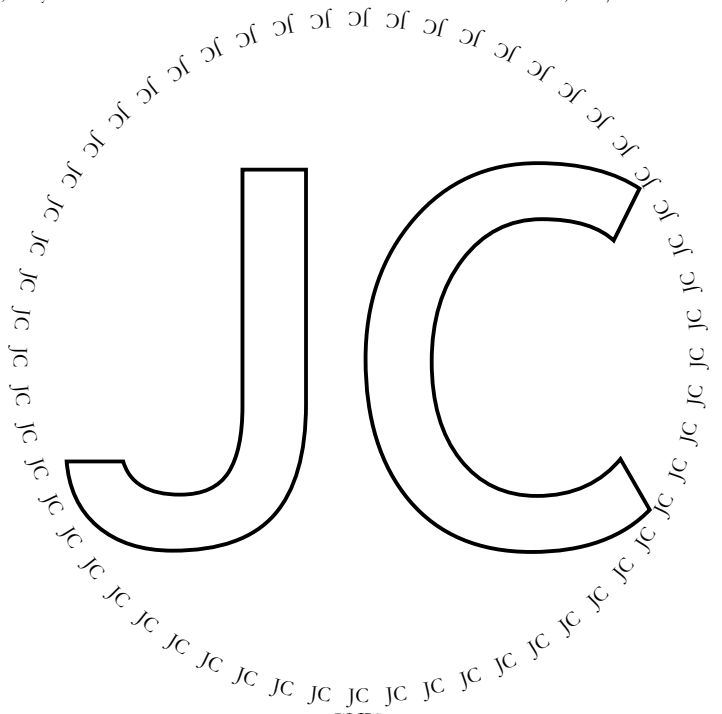
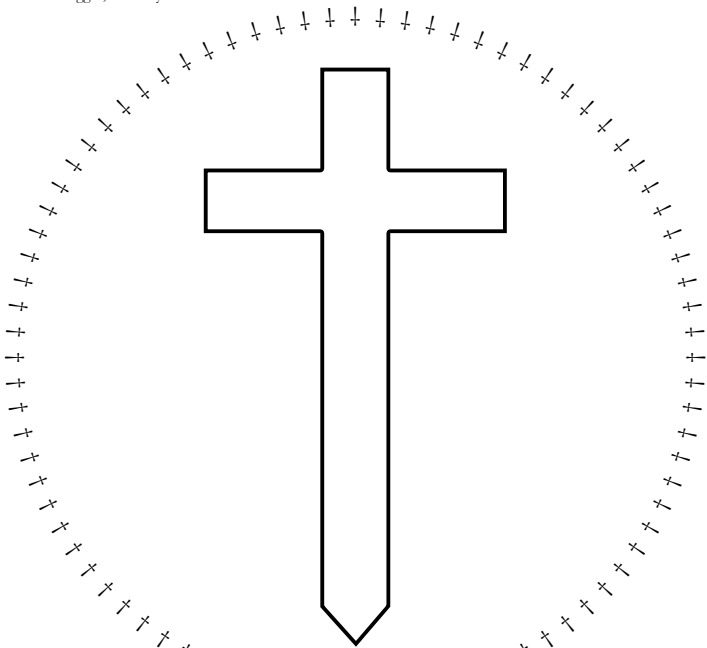

Times Eye Nose Mouth Score

†

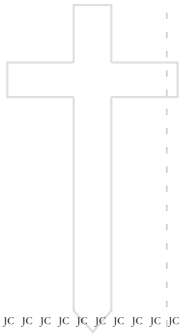

JC



JDAW



MPM



ARM



WPS



What is it?

JC

JDAW

MPM

ARM

WPS

Total

†

JC

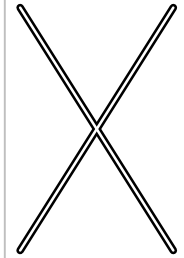

JDAW

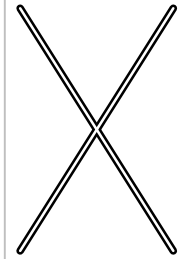

MPM

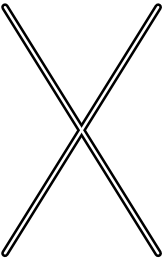

ARM

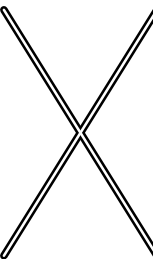

WPS

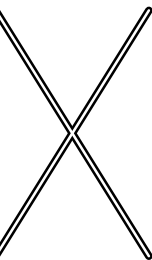

Total

The Corks

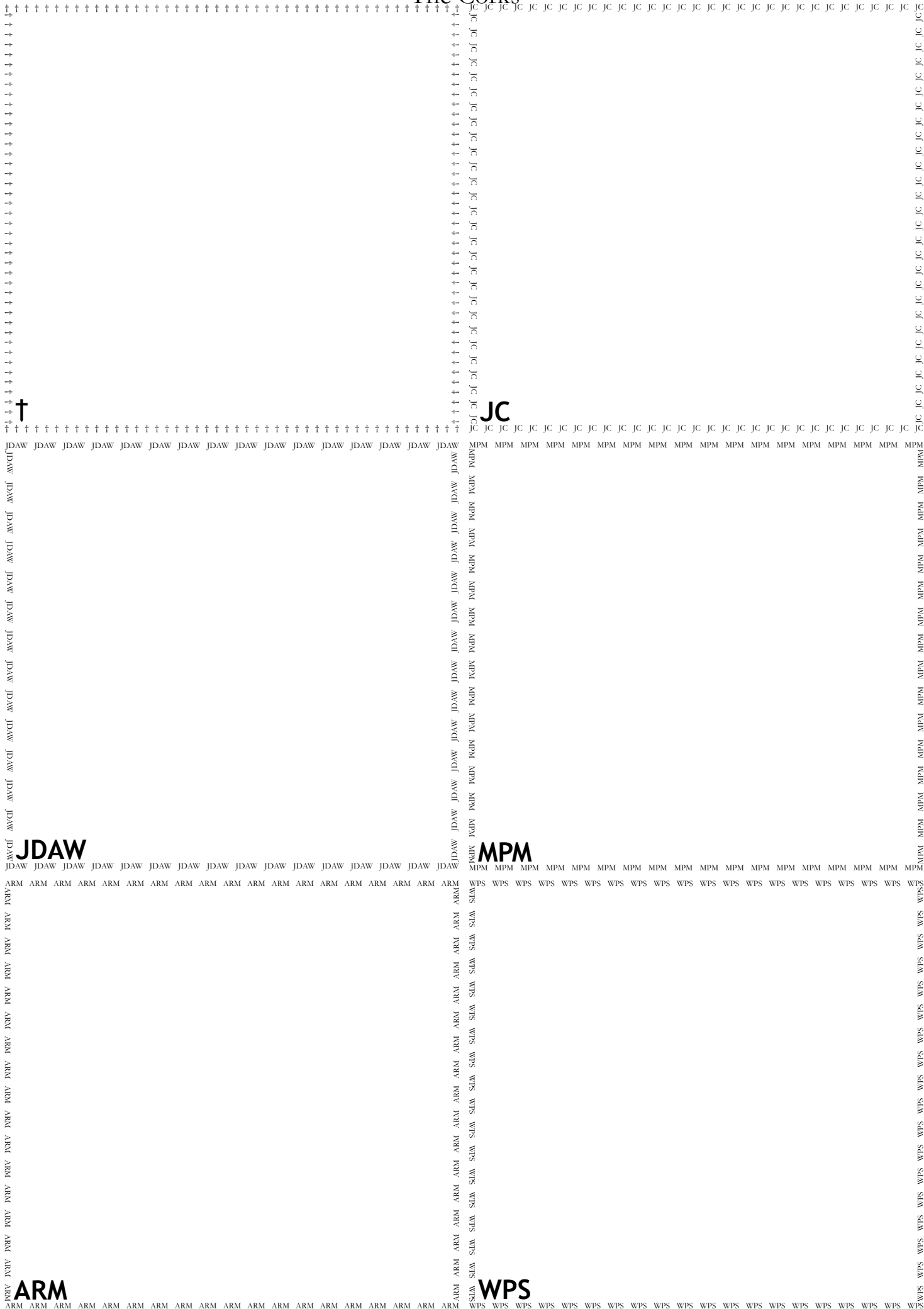

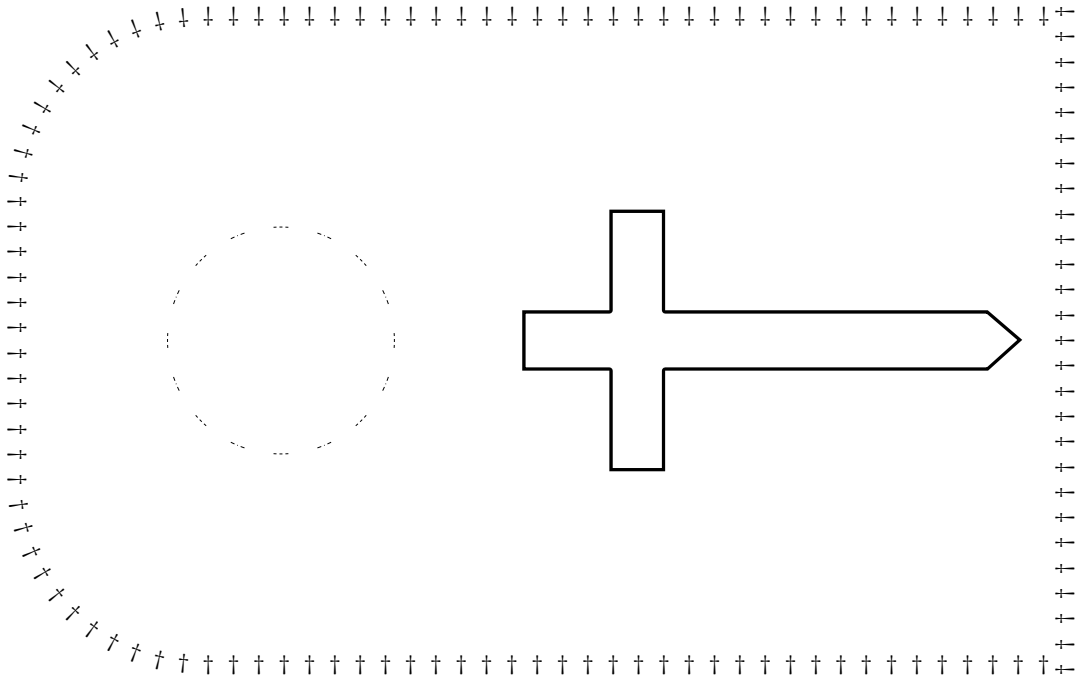
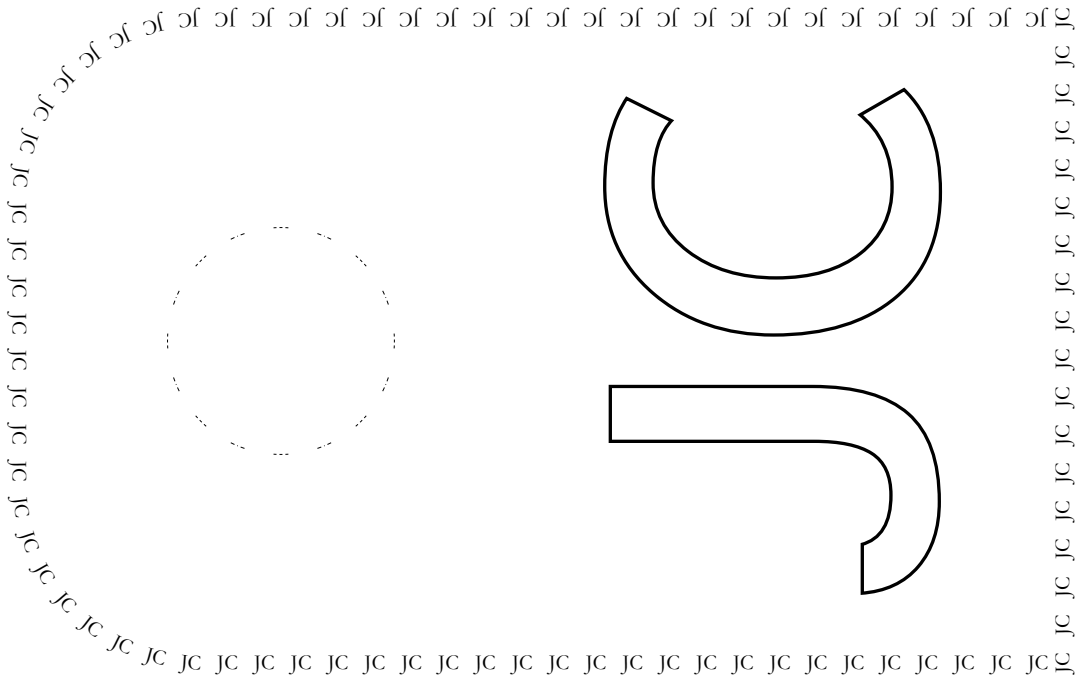
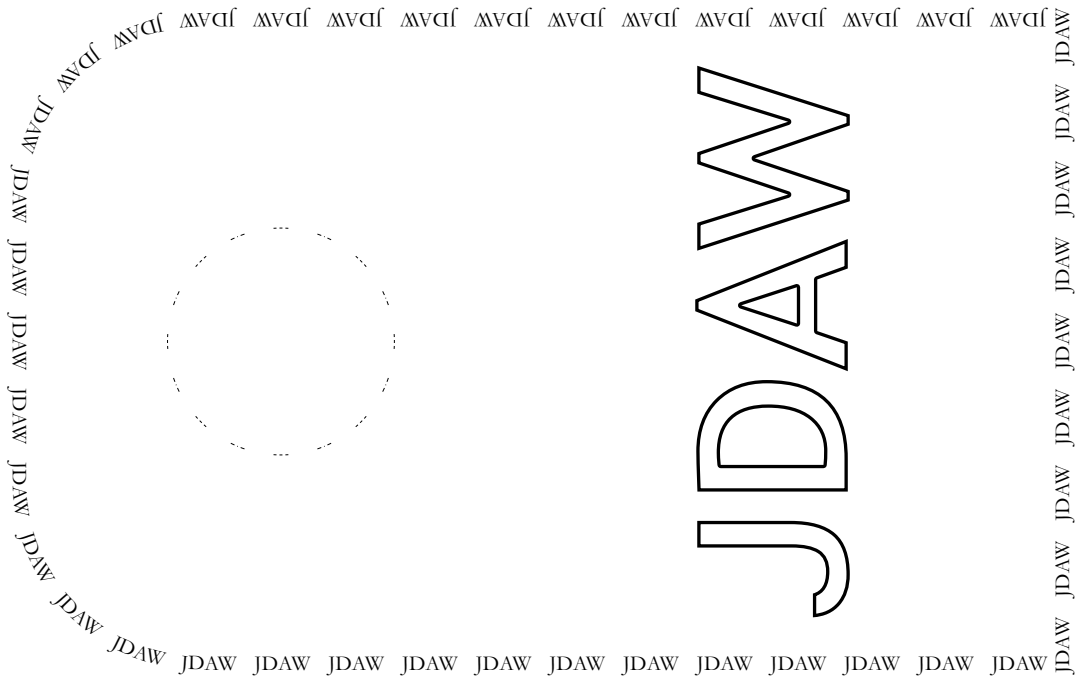

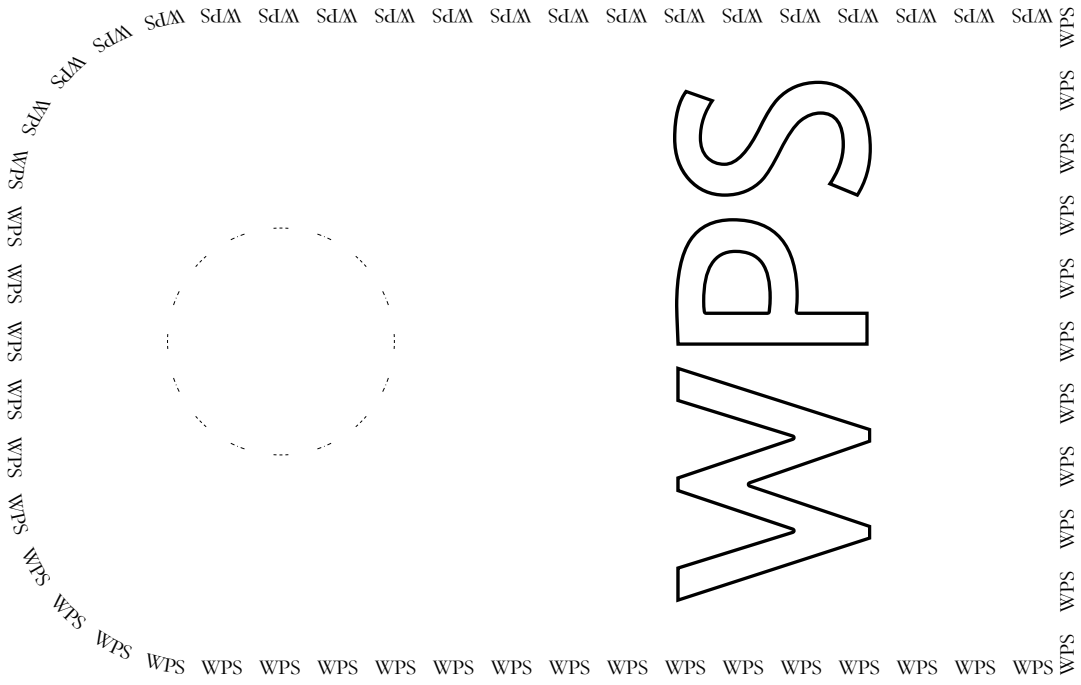

WPS

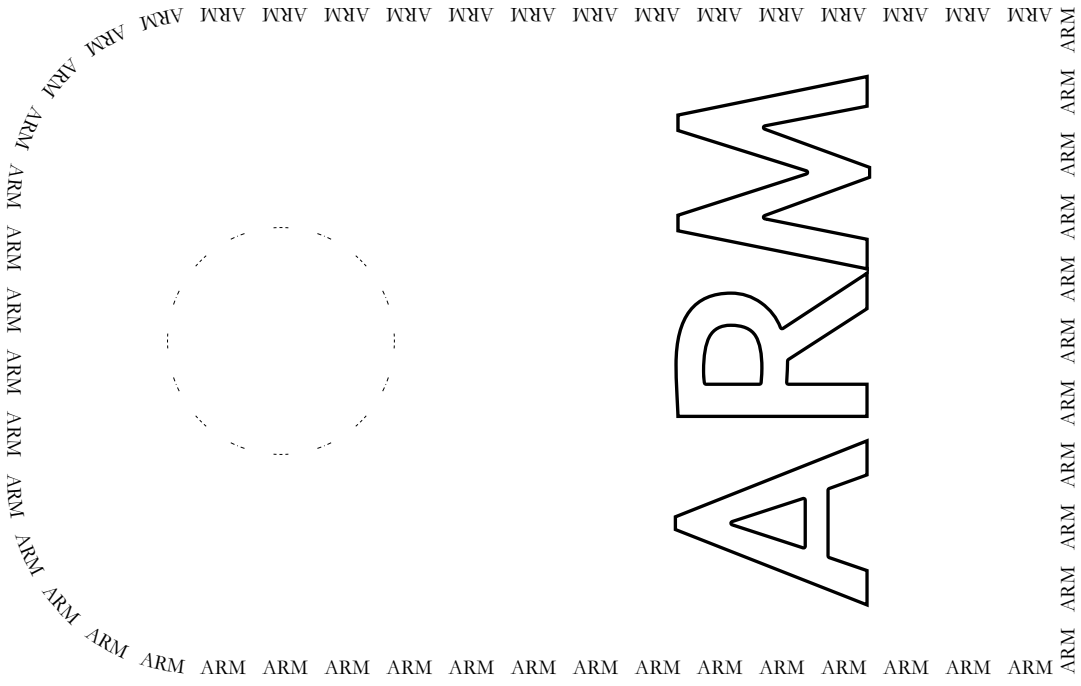

ARM

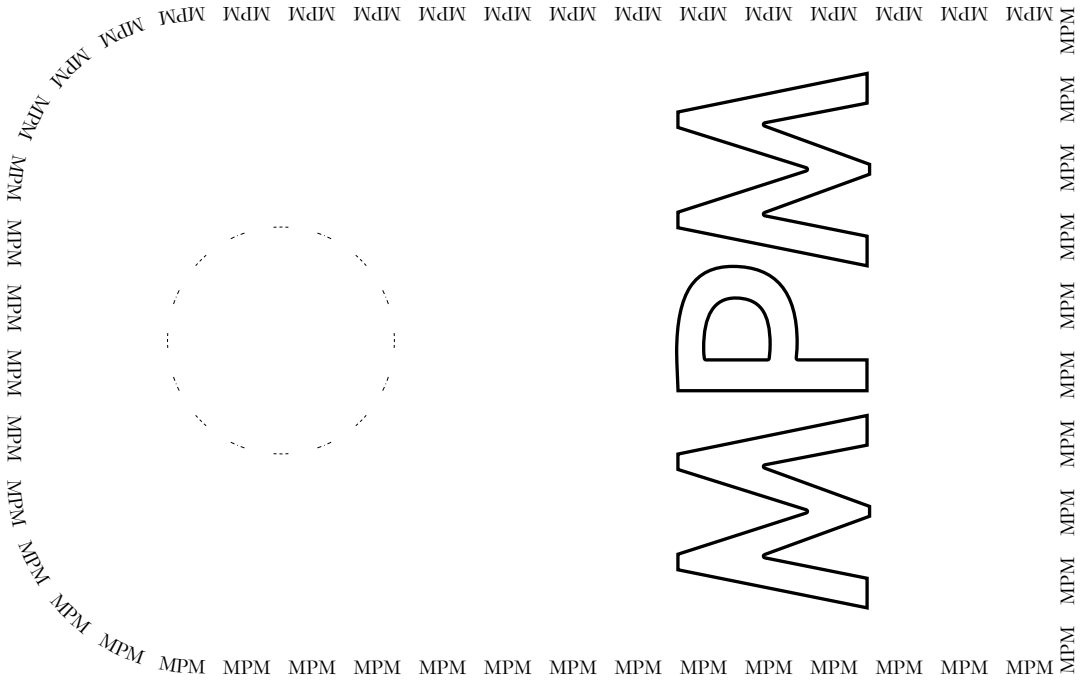

MPM

+

JC

JDAW

MPM

ARM

WPS

© Copyright 2017 Julian D. A. Wiseman of www.jdawiseman.com
This work is licensed under a Creative Commons Attribution-ShareAlike 4.0 International Licence.
http://creativecommons.org/licenses/by-sa/4.0/deed.en_GB

product = Acrobat Distiller 11.0; languagelevel = 3; version = 3018.101; revision = 0; usertime = 55277817

Software version = SoftwareVersionDateAdobeFormat = D:201710152300 = 23:00 Sun 15 Oct 2017
These placemats ~ ParametersVersionDateAdobeFormat = D:201710181950 = 19:50 Wed 18 Oct 2017

Used paper types: A4 = 210mm*297mm.

External links for PDF sidebar:

Thread on ThePortForum.com = http://www.theportforum.com/viewtopic.php?t=11843&view=unread#unread
Latest version this placemat = http://www.jdawiseman.com/2017/20171019_mature.pdf
in list of placemats = http://www.jdawiseman.com/papers/placemat/placemats_list.html#a20171019
Boot & Flogger = http://www.davy.co.uk/wine-bar/boot-and-flogger/
SE1 1TA, streetmap.co.uk = http://www.streetmap.co.uk/map.srf?x=532409&y=180083&z=106&pc=SE1+1TA
SE1 1TA, google.co.uk = http://www.google.co.uk/maps/?cid=4115942643
000130790&api=1&map_action=pano&viewpoint=51.5042,-0.0934337&heading=-15&pitch=0
SE1 1TA, bing.com = http://www.bing.com/maps/default.aspx?where1=SE1+1TA&cp=51.50428--0.0935
What3Words: cafe.humid.palace = http://map.what3words.com/cafe.humid.palace
Manual of placemat software = http://www.jdawiseman.com/papers/placemat/placemat.html
Software discussion = http://www.theportforum.com/viewtopic.php?t=175&start=9999#bottom
Parameters, examples = http://www.theportforum.com/viewtopic.php?t=5837&start=9999#bottom
Placemats, list = http://www.jdawiseman.com/papers/placemat/placemats_list.html

Fonts: /TrebuchetMS-Bold (TitlesFont); /Garamond (CircleTextFont, NamesFont, HeaderFont); and perhaps others.

Array equalities: {Circlearrays = CirclearraysTastingNotes = CirclearraysVoteRecorder = CirclearraysCorkDisplay = CirclearraysNeckTags};
{Titles = TitlesTastingNotes = TitlesVoteRecorder = TitlesCorkDisplay}; {Names = NamesTastingNotes = NamesVoteRecorder}.

InlineTitles = true; InlineAboveTitles = true; InlineBelowTitles = false; InlineOverTitles = false; InlineTitlesMaxNumberContours = 1;
InlineTitlesBlackWidth = 1.44; InlineTitlesWhiteWidth = 2.88; InlineAboveTitlesMaxNumberContours = 1; InlineAboveTitlesBlackWidth = 0.72;
InlineAboveTitlesWhiteWidth = 1.44

TastingNotesCirclesBehind = true; TastingNotesCirclesBehindFadingFactorIfAllBlack = 0.125; TastingNotesCirclesBehindFadingFactorIfAnyGrey = 0.2;
TastingNotesCirclesBehindTopX = { [0 1 0 0.5 1 1 0.5 0.5 0] TastingSheetNum 9 mod get }; TastingNotesCirclesBehindBottomX = { [0 1 0 0.5 1 1 0.5 0.5 0] TastingSheetNum 1 add 9 mod get }

SheetNum=0, with 6 glasses: best BaseStyle, with radius 131.315, is /RectangularDislocation with 3 rows and 2 columns. Of non-margin area
75.3803% within circles = 83.1187% of infinite-plane exact-hexagonal maximum.

Radii = [131.315] => SheetNum 0 diameter ~ 92.7mm ~ 3.65".

GlassesOnSheets = [[0 1 2 3 4 5]]

GlassesOnTastingNotePages = GlassesOnSheets

Titles, ASCIIified and re-arranged by GlassesOnSheets = [[(+) (JC) (JDAW) (MPM) (ARM) (WPS)]]

CircleTextMaxFontSizeAbsolute = 8; CircleTextMaxFontSizeProportionRadius = 0.1; CircleTextMaxFontSizeMayBeSlightlyExceeded = true.

CircleTextsTweakSizeScores: Score=4.89194 and FontSizes=8.01055, all of them

CirclearraysFontSizes = 8.01055, all of them. CirclearraysFontSizes/Radii = 0.0610026, all of them.

CirclearraysUnroundedN = [[84 56 30.2078 32 32 36]].

CirclearraysN = [[84 56 30 32 32 36]].

RadiiCirclearrayBaseline = [129.285]. RadiiCirclearrayInside = [124.03].

Binding constraints on TitleFontSizes as SheetNum, WithinPage, WithinTitles, Title: 0,0,0,dagger; 0,1,1,JC; 0,2,2,[(JDA) { -0.06 Kern } (W)] ; 0,3,3,[(MP) { -0.06 Kern } (M)] .

TitleFontSizes = [[255.656 198.971 91.3286 116.719 116.719 116.719]].

TitleMaxHeightProportionInnerRadius directly relevant for these WithinTitles and Titles: 0 = +.

Title heights / RadiiCirclearrayInsideUsableTAB = [[1.75 1.18552 0.541213 0.68697 0.691675 0.69544]].

WaterBoxes on SheetNum 0 with radius 131.315: WaterBoxesSize = 10.4606; WaterBoxesGap = 2.61515; WaterBoxesNum = 15

Neck tags: scaling factors = [0.863547] (with ThisPageOrdering = 1), and scaled TitleFontSizes = [[220.771 171.821 78.8666 100.792 100.792 100.792]].

URL # tags: Glasses_0 ... Glasses_5; TastingNotes_0 ... TastingNotes_5; VoteRecorder_0 ... VoteRecorder_2; CorkDisplay_0; NeckTags_0, NeckTags_1; DecanterLabels_0; DistillationLog; and also 6 glass-circle zooms of the form Circle_#NameNum_#SheetNum_#WithinPage, the first being Circle_00_00_00 and the last being Circle_00_00_05.

Only log output remaining:

usertime = 55281700, so about 3.9 seconds to execute code, excluding parameter assignments and log page(s).

2 = vmstatus pop pop: should = 1|2 and does :-)
0 = CountClipStack: should = 0 and is :-)
0 = CountGraphicsStack: should = 0 and is :-)
3 = countdictstack: should = 3 and is :-)
0 = count: should = 0 and is :-)

Opacity comparator, trial version: comments to www.ThePortForum.com/viewtopic.php?t=5610&view=unread#unread

